



Kia Genuine Accessories











Vehicle Model Forte 2-Door & 4-Door
 Model Year 2014 ~
 Part No. A7017 ADU00 / A7017 ADUP0

Accessory CARGO NET
 Difficulty B

- Accessory Installation

Note: Difficulty stated above reflects the minimum level of expertise required to install the accessory
 (A) Customer (B) Dealer Technician (C) Master Technician

Instructional Symbols / Definitions

	Denotes warnings that may lead to serious physical injury or vehicle damage.		Denotes quality processes to be checked prior to moving to the next step.	Denotes safety equipment required to be used such as a mask, goggles, rubber gloves, and hearing protection.	
	Denotes cautions to be taken to avoid physical injury or electronic component damage.		Denotes specific tools that are necessary to complete the step.		
	Denotes cautions to be taken to avoid vehicle and component damage.		Denotes instructional steps necessary to complete the process.		
				Mask	Goggles
				Rubber Gloves	Hearing Protection

Basic Required Hand Tools

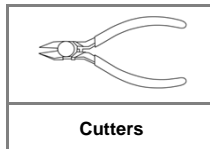

CAUTION: Cargo nets are constructed of elastic and netting and can cause injuries or entanglement. Avoid risky or careless use, especially by unsupervised children.

Avoid eye injury. **DO NOT** overstretch the cargo net, **ALWAYS** keep your face and body out of cargo net's recoil path.

NOTE: This vehicle's cargo net is equipped with upper bungee hook clips to aid in the retention of items placed in the net.

It is recommended that when not using the cargo net to carry items, the hook clips remain unfastened. See step 2 on page 8 for details.

Contained are detailed instructions for the use of the hook clips. After installation of the net, please place the installation instructions in the vehicle glove compartment for later use if needed.

Notes to the Installer:

Read the entire installation pamphlet prior to beginning the installation of the accessory.

Ensure that the vehicle is properly protected in the area that the accessory is to be installed.

To prevent vehicle damage, never place tools on top of painted surfaces, seats, dash pad, console or floor carpet / mat.

Always wear appropriate safety gear to include gloves and eye protection when required.

Kia Genuine Accessories

Kit Overview

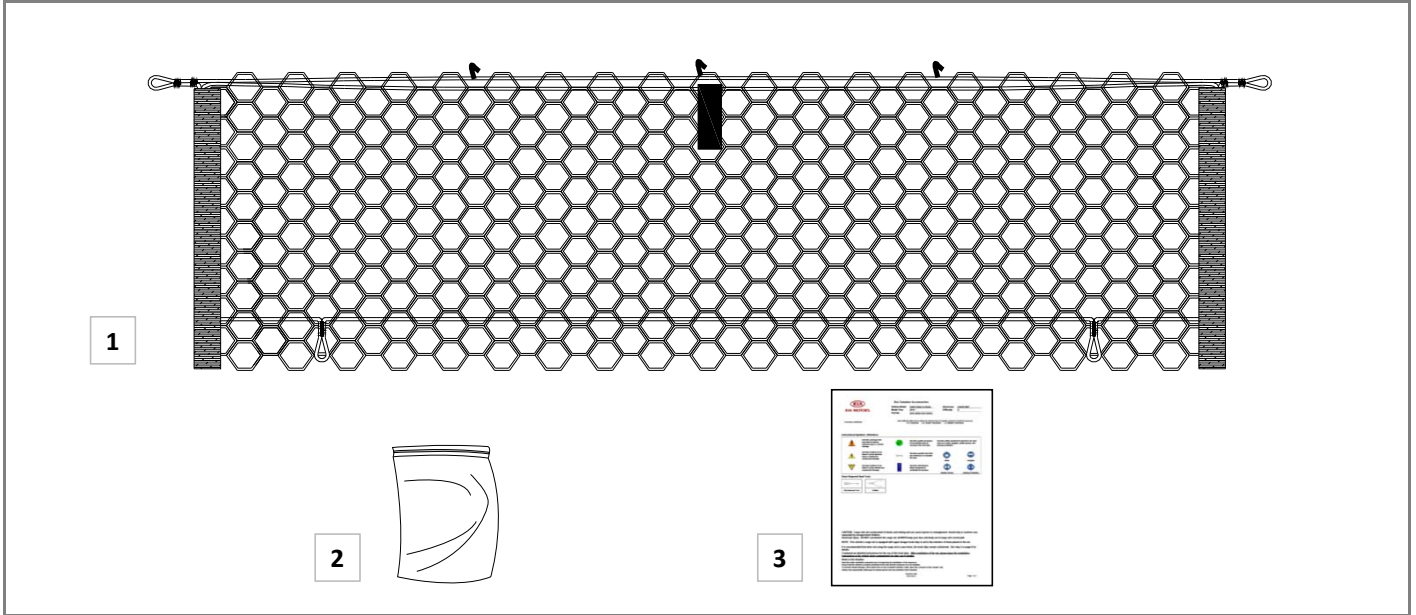

No.	Qty	Description
1	1	Cargo net
2	1	Hardware Kit
3	1	Installation Instructions

Hardware Overview

A	
4	Black T-Anchor

B	
2	Self Tapping Screw

C	
2	Weld Stud

D	
2	Plastic Washer

Hardware Kit Total	
10	

Kia Genuine Accessories

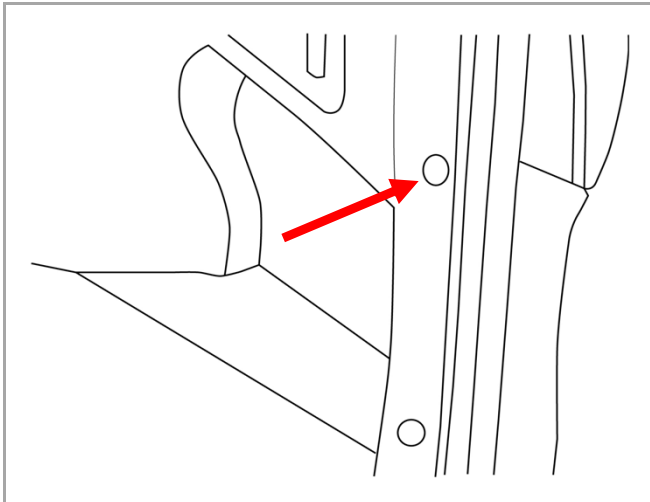

		1
---	--	----------

N O T E	1. On the passenger side, locate the upper panel fastener on the inside of the trunk compartment as shown.
----------------------------	--

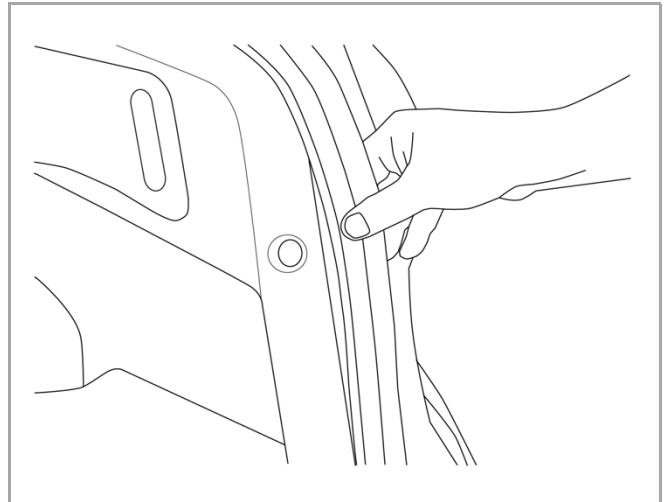

		2
---	--	----------

N O T E	1. Gently pull the rubber trunk seal outward to expose edge of trunk felt liner.
----------------------------	--

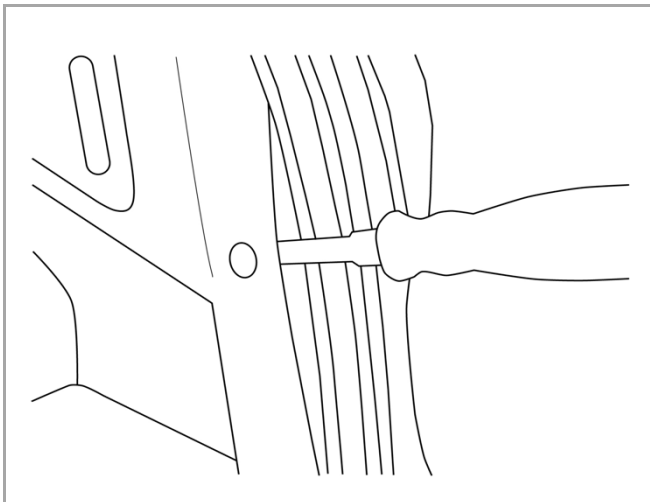

	Clip Removal Tool	3
---	--------------------------	----------

N O T E	1. Using a clip removal tool, carefully insert it between the trunk felt liner and the metal mounting tab. 2. Gently pry the panel fastener out to gain access.
----------------------------	--

	DO NOT allow the clip removal tool to press against the rubber seal. DO NOT over stress the metal mounting tab.
---	--

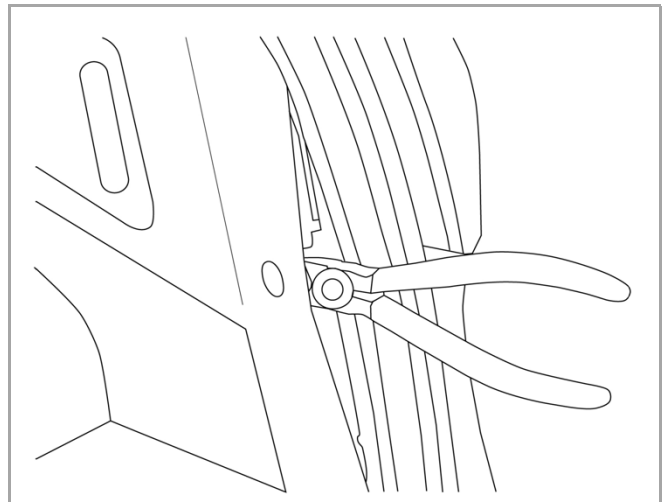



	Cutters	4
---	----------------	----------

N O T E	1. Using cutters, insert them between the trunk felt liner and the metal mounting tab. 2. Snip off the head of the panel fastener and discard.
----------------------------	---

	DO NOT allow the cutters to press against the rubber seal. DO NOT over stress the metal mounting tab.
---	--

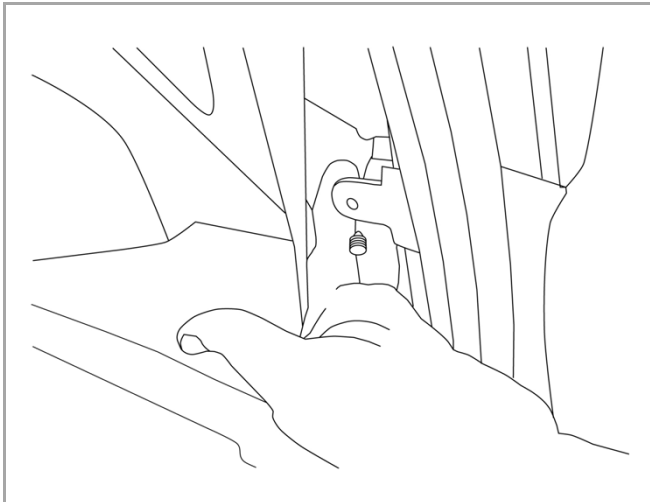
Kia Genuine Accessories



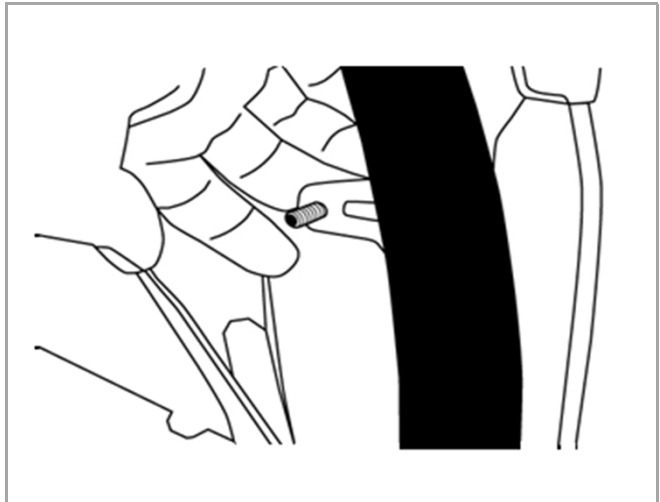

	5
N O T E	<ol style="list-style-type: none"> 1. Insert your hand behind the metal mounting tab to catch the tip of the panel fastener and discard.

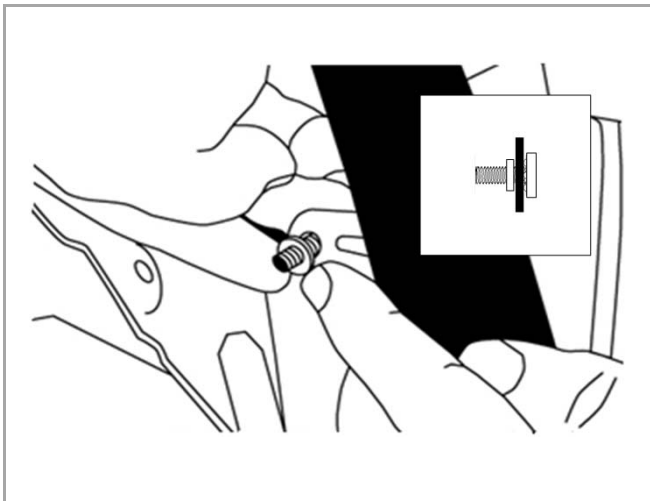

	6
N O T E	<ol style="list-style-type: none"> 1. Pull back trunk felt liner to allow access to the metal mounting tab. 2. Insert weld stud from behind into the metal mounting tab and hold into place.





	7
N O T E	<ol style="list-style-type: none"> 1. While holding the weld stud firmly from behind, push the plastic washer over threaded end.
	Use caution when installing the weld stud so it does not fall out or drop while securing the plastic washer.
	Ensure you have fully seated the plastic washer tightly against the metal tab.



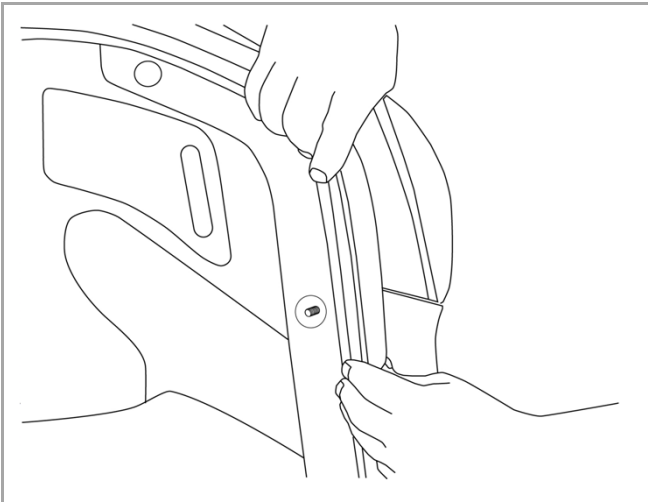

	8
N O T E	<ol style="list-style-type: none"> 1. Carefully line up the hole in the trunk felt liner and pull it over the installed weld stud.

Kia Genuine Accessories

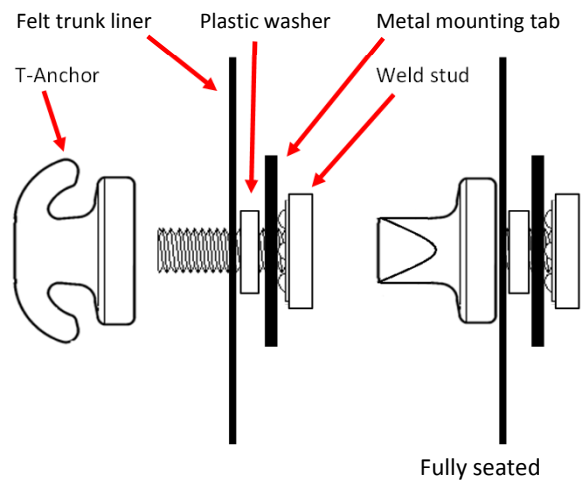
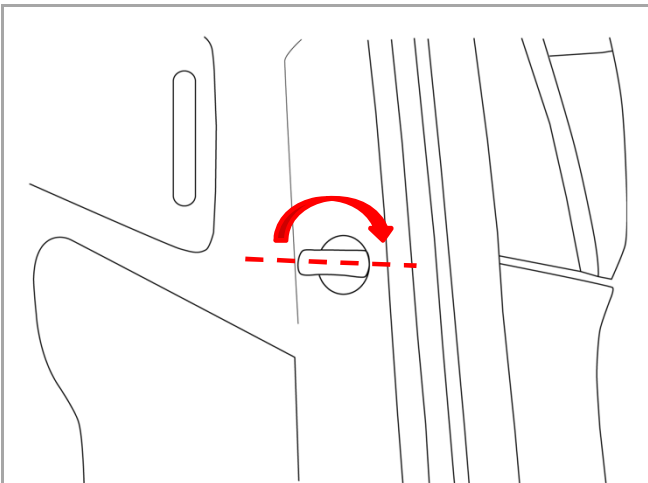

	9
N O T E	<p>1. Align channel of rubber seal with metal lip and push to install. Push firmly along entire edge to ensure it is correctly seated.</p>
	<p>Ensure there is no glue residue remaining on the vehicle from the rubber seal.</p>



	10
N O T E	<ol style="list-style-type: none"> 1. Using only your hands, screw in one (1) T-Anchor onto the weld stud, tighten to a snug fit. 2. Tighten the T-Anchor to a horizontal position as shown. 3. If movement or a gap is found, further tighten 1/4 - 1/2 increment turns until the T-Anchor is seated to a horizontal position as shown. 4. Repeat steps 1 through 11 on driver's side of the vehicle.

Kia Genuine Accessories

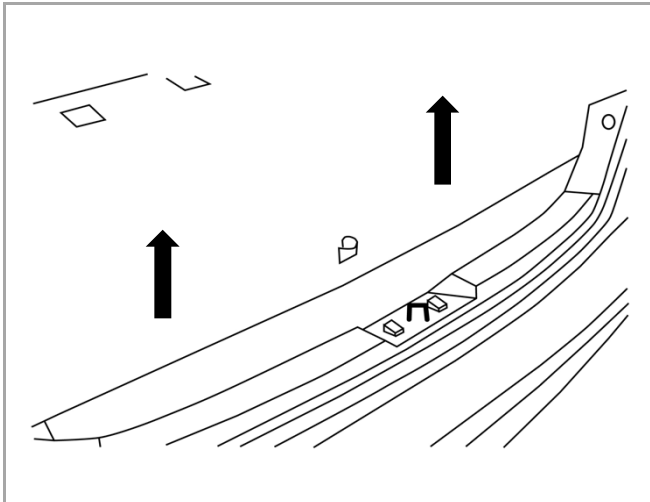

		11
N O T E	<ol style="list-style-type: none"> 1. Remove the trunk floor liner from the trunk area. Place on a clean dry area. 	
	Place the trunk floor liner on a clean dry area.	

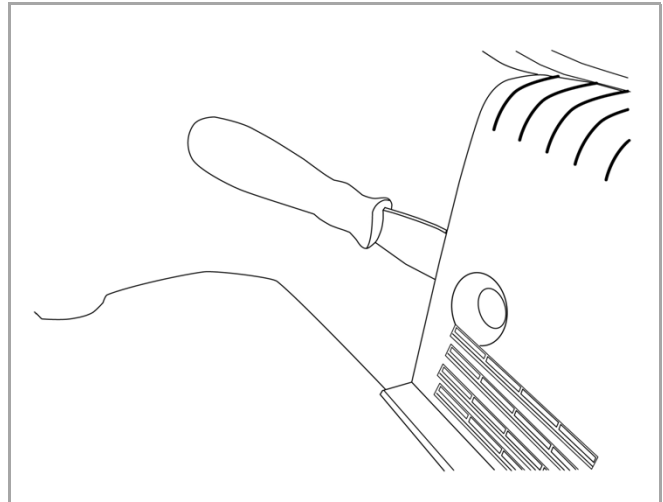

	Clip Removal Tool	12
N O T E	<ol style="list-style-type: none"> 1. Locate the outside panel fastener shown on the passenger side. 2. Using a clip removal tool, slide it between the rear plastic sill panel and the trunk felt liner. 3. Gently disengage the panel fastener by prying between the rear plastic sill panel and the trunk felt liner and discard the panel fastener. 4. Repeat for drivers side. 	
	Rear plastic sill panel has three plastic panel fasteners, only remove the two outer panel fasteners. DO NOT remove the rear plastic sill panel.	

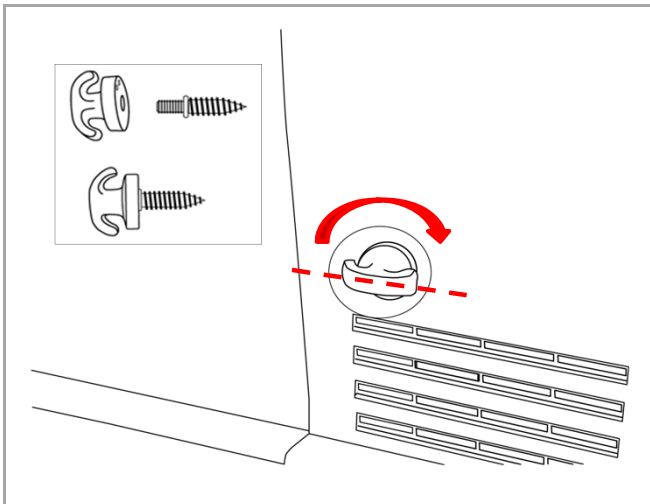

		13
N O T E	<ol style="list-style-type: none"> 1. Assemble two (2) T-Anchors, and two (2) self tapping screws as shown. 2. Using only your hands, screw in one (1) T-Anchor through the hole on the back of the rear plastic sill panel. 3. Tighten the T-Anchor to a horizontal position as shown. 4. Repeat for driver's side. 	
	DO NOT over tighten the T-Anchor so you do not strip out the retention hole.	

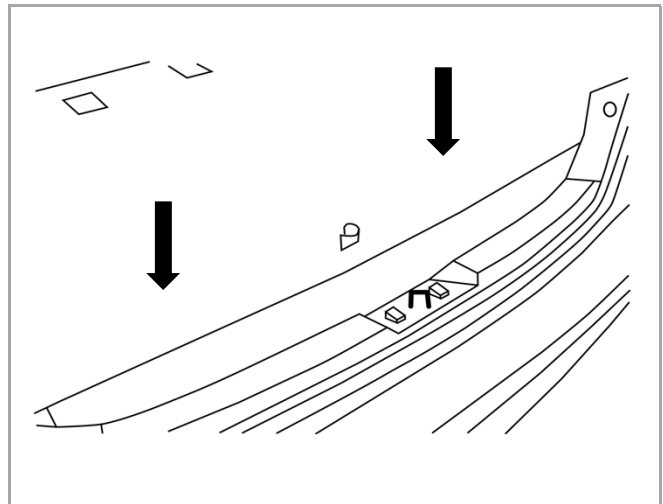

		14
N O T E	1. Re-install the trunk floor liner into the trunk area.	

Kia Genuine Accessories

		15
N O T E	<ol style="list-style-type: none"> 1. Orient the net so the opening is in the up position and the pull tab is facing rearward to the T-Anchors. 2. Attach both the upper bungee loops first as shown. 3. Attach both the lower cord loops as shown. 4. Ensure the lower cord loops attached are towards the bottom of the T-Anchor. 	
	<p>Ensure both upper bungee loops and lower cord loops are securely fastened.</p>	

		16
N O T E	<ol style="list-style-type: none"> 1. Correctly installed cargo net. 	

Kia Genuine Accessories

Hook Clips

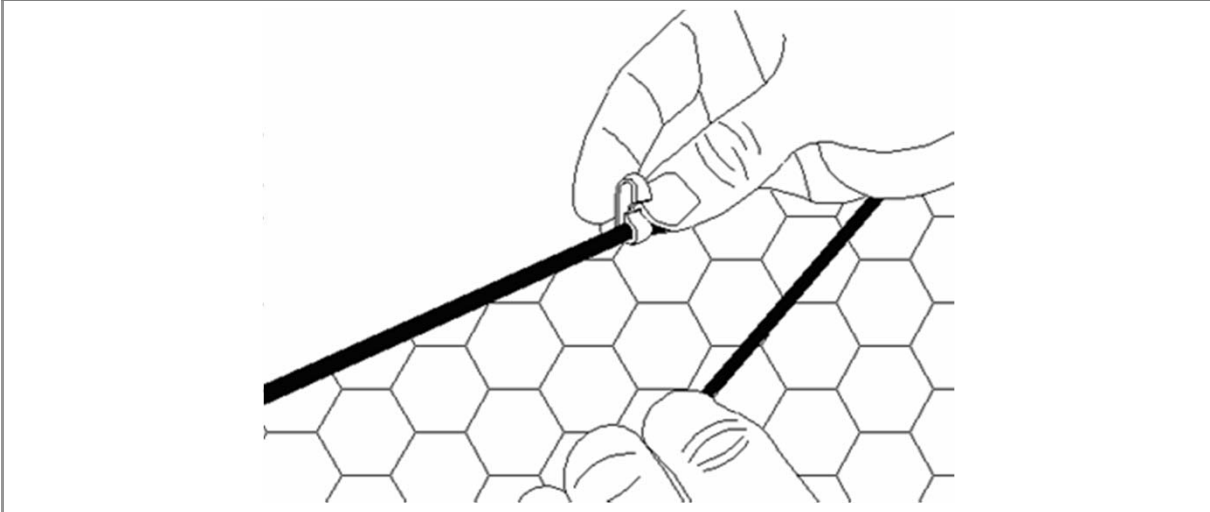

1

NOTE

1. Locate the three hook clips located along the top of the cargo net.

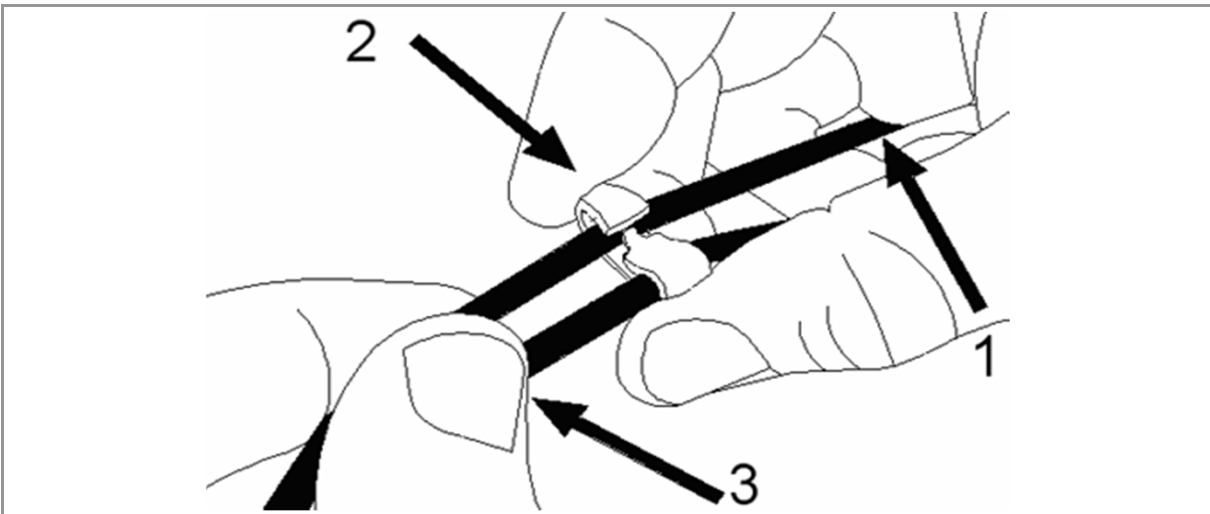

2











NOTE

1. Grasp the bungee cord you will be sliding into the clip and wrap two or three fingers around to hold securely.
2. With the same hand, use your index finger and thumb to hold the hook clip.
3. With the other hand, grasp the bungee and while pulling away from the hook clip, slide the bungee up into the clip to fasten or pull out of the clip to unfasten.



Ensure bungee is fully seated in the hook clips.

Kia Genuine Accessories

Function Check	Results
 Pull tab location.	Pull tab to face rear of vehicle.
 Ensure the T-Anchors are tight and correctly oriented.	T-anchors are in the proper position.
 Ensure bungee loops and cords are secure to all T-Anchors.	Bungee loops and cords are secure to all T-Anchors.
 Net opening.	Net opening must be at the top.
 Confirm all debris is removed from the vehicle.	Work area is clean.
 Confirm all panels are correctly reinstalled in the vehicle.	Panels correctly reinstalled.
 Confirm the trunk floor is correctly reinstalled in the vehicle.	Trunk floor is correctly reinstalled.
 Confirm all customer belongings are placed back into the vehicle trunk.	Customer belongings replaced.
 Ensure ALL tools are removed from the vehicle.	Tools removed.
 Ensure trunk is closed and latched.	Trunk closed and latched.
 Installation Instructions.	Ensure Installation Instructions are placed in glove compartment.